

HIGH END SIDM PRINTING: SURVIVING THE CHALLENGE

ANGELO GIORGETTI
Director, Compuprint Division Planning & System Engineering
BULL HN INFORMATION SYSTEMS ITALIA

HIGH END SIDM PRINTING: SURVIVING THE CHALLENGE

- **THE MARKET SCENARIO**
- **THE CHALLENGE**
- **AN INNOVATIVE APPROACH**

HIGH END SIDM PRINTING: SURVIVING THE CHALLENGE

- THE MARKET SCENARIO

Compuprint Division

BPCC - 3 -

Bull



DESK TOP PRINTERS - MARKET SCENARIO

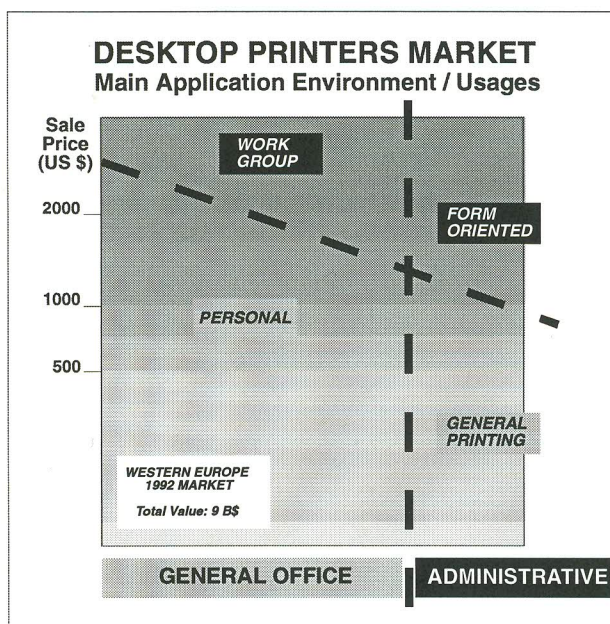

GROWING MARKET
for
GENERAL OFFICE
APPLICATIONS



STABLE MARKET
for
ADMINISTRATIVE
APPLICATIONS



Compuprint Division

BPCC - 4 -

Bull



DESK TOP PRINTERS - TECHNOLOGIES

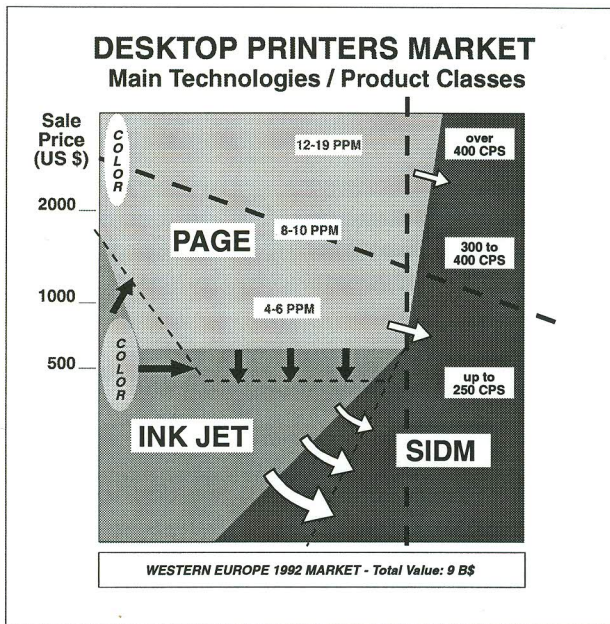

WHICH
FUTURE
for
S.I.D.M.

?

Compuprint Division

BPCC - 5 -

Bull 

HIGH END S.I.D.M. MARKET

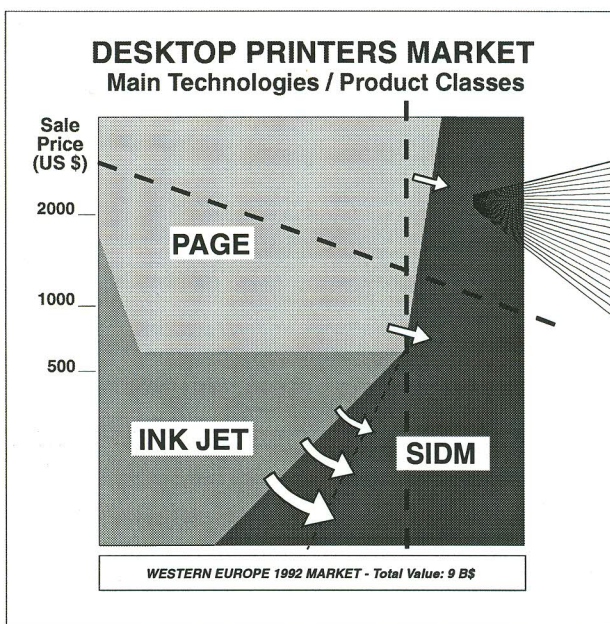

WHICH
FUTURE
for
HIGH END
S.I.D.M.

?

Compuprint Division

BPCC - 6 -

Bull 

HIGH END S.I.D.M. - WHY ?

A BULL COMPUPRINT SURVEY
ON 50 U.S. USERS OF 400+ CPS SIDMs

➔ **PURCHASING REASONS**

1st - OVERALL COSTS

2nd - FORM CAPABILITIES

➔ **14% WOULD CONSIDER A LASER
PRINTER FOR THE FUTURE**

Compuprint Division

BPCC - 7 -

Bull 

HIGH END S.I.D.M. PRINTING - WHAT?

A BULL COMPUPRINT SURVEY ON 50 U.S. USERS OF 400+ CPS SIDMs

● APPLICATIONS

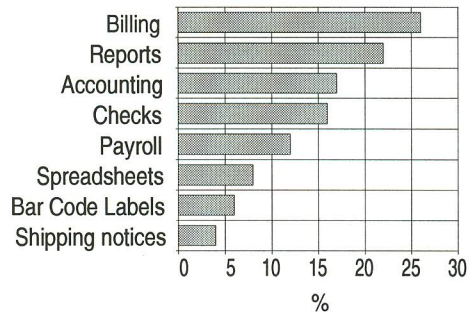

● MEDIA

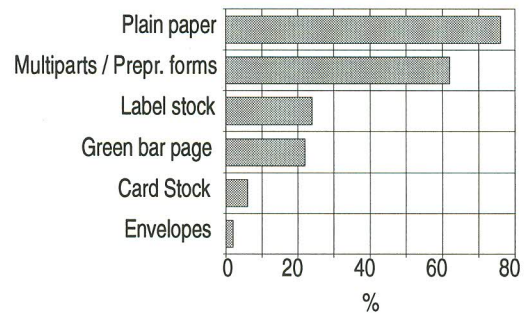

Compuprint Division

BPCC - 8 -

Bull 

HIGH END S.I.D.M. - THE DRIVING APPLICATIONS

NO NEW APPLICATIONS

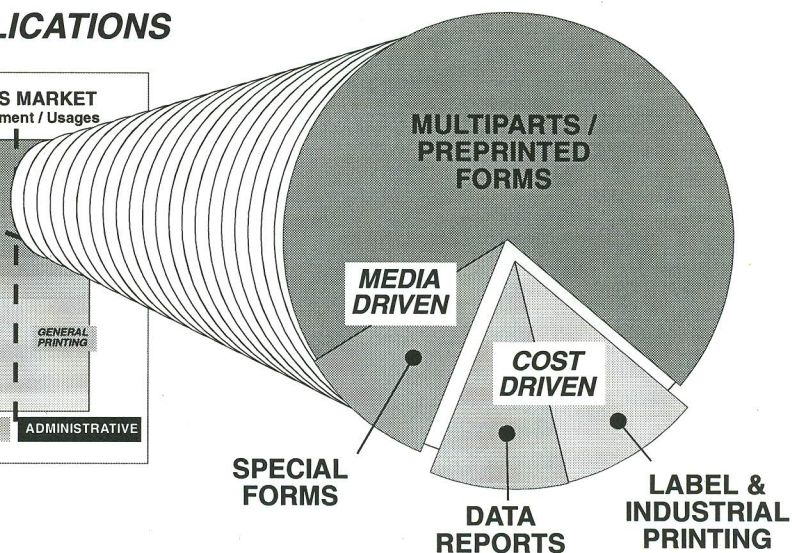
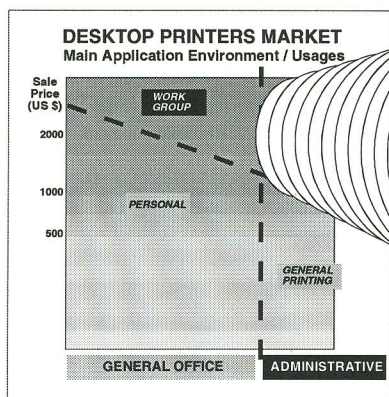

Compuprint Division

BPCC - 9 -

Bull



HIGH END S.I.D.M. - THE DRIVING APPLICATIONS

MULTIPARTS/ PREPRINTED FORMS

- Invoices and billing
- Order forms
- Checks and negotiables

WILL REMAIN a STRONG MARKET
for HIGH END SIDMs:

- Copies
- Colour Preprinted Forms

SPECIAL FORMS

- Card stock
- Extra Wide paper

WILL REMAIN AN IMPORTANT APPLICATION
for HIGH END SIDMs

DATA REPORTS

- NO MORE THE MOST IMPORTANT**
- long reports disappear
 - short reports printed on non-dedicated printers

SIDM STILL REQUIRED for

- reliability
- cost/page
- servicing

LABEL & INDUSTRIAL PRINTING

SMALL NICHE

- Cost of Ownership versus dedicated thermal transfer line printers (3-10 IPS)

Compuprint Division

BPCC - 10 -

Bull



HIGH END S.I.D.M. - THE FRAGMENTED INDUSTRY OFFER

400+ CPS CLASS
(W.E. 1992)

Source: DATAQUEST
Bull elaboration

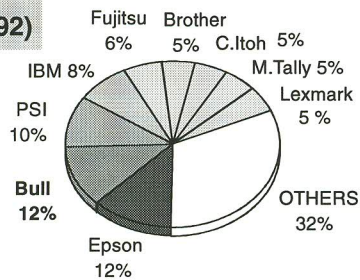

(TOTAL SHIPMENTS: ~ 120 kunits)

MORE THAN 14 MANUFACTURERS



6 VENDORS TO SERVE 50% OF THE MARKET

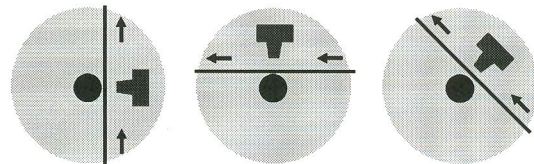

SEVERAL ARCHITECTURAL "FLAVOURS" TO SERVE THE MARKET

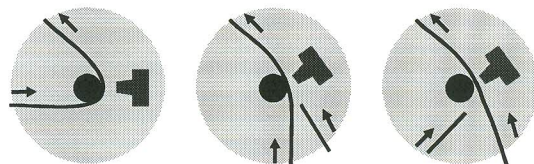

Compuprint Division

BPCC - 11 -

Bull



HIGH END S.I.D.M. MARKET

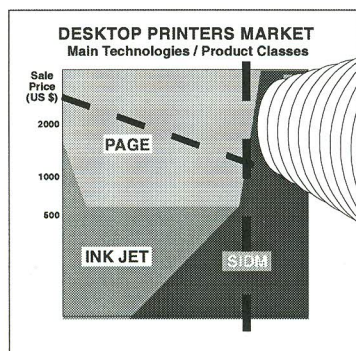

MATURE
NO NEW APPLICATIONS
NEGATIVE GROWTH RATE



FRAGMENTED
DIFFERENT APPROACHES
MANY VENDORS

Compuprint Division

BPCC - 12 -

Bull



HIGH END S.I.D.M. MARKET

THE MANUFACTURER DILEMMA

WHICH INDUSTRIAL STRATEGY



DIVEST



MAINTAIN



INVEST



HIGH END SIDM PRINTING: SURVIVING THE CHALLENGE

- THE CHALLENGE



THE S.I.D.M. FUTURE

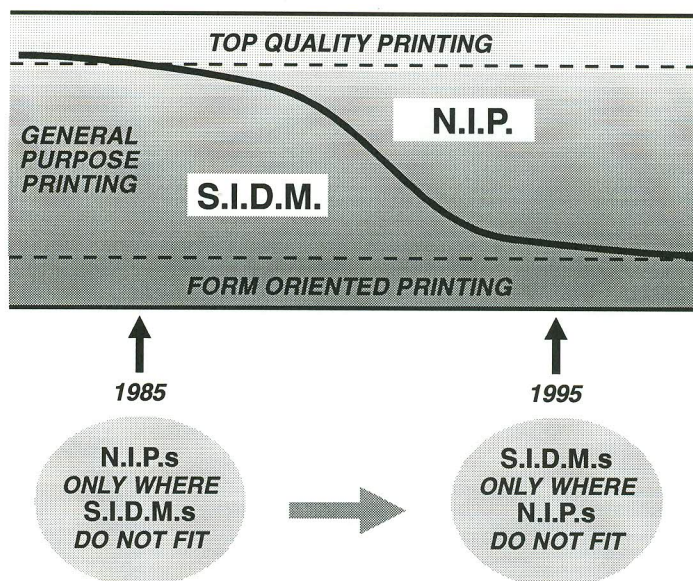

THE S.I.D.M. FUTURE

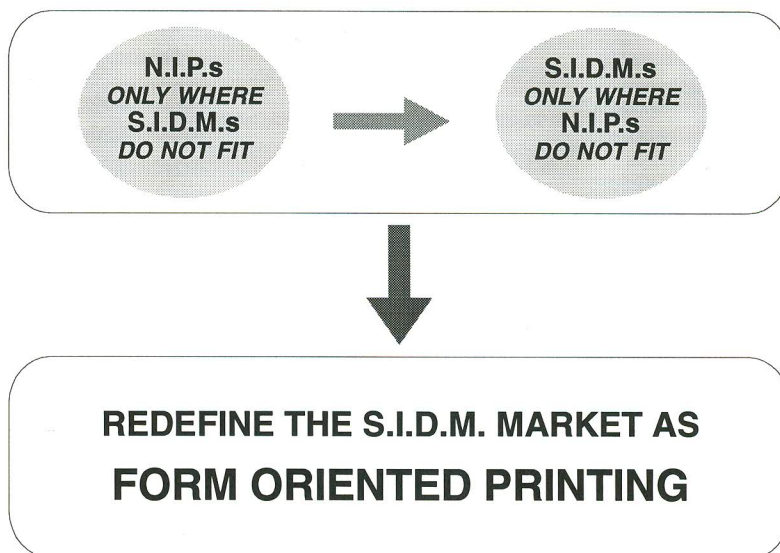

FORM ORIENTED PRINTING

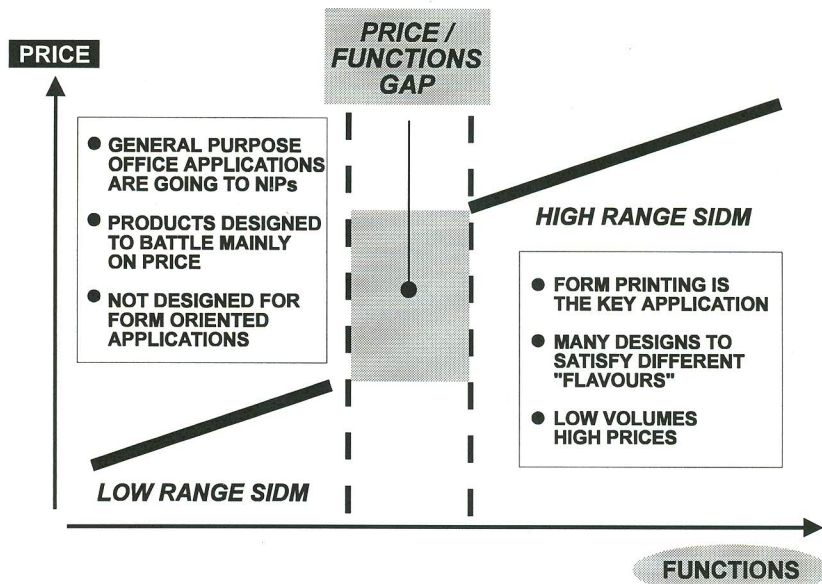

Compuprint Division

BPCC - 17 -

Bull



FORM ORIENTED PRINTING

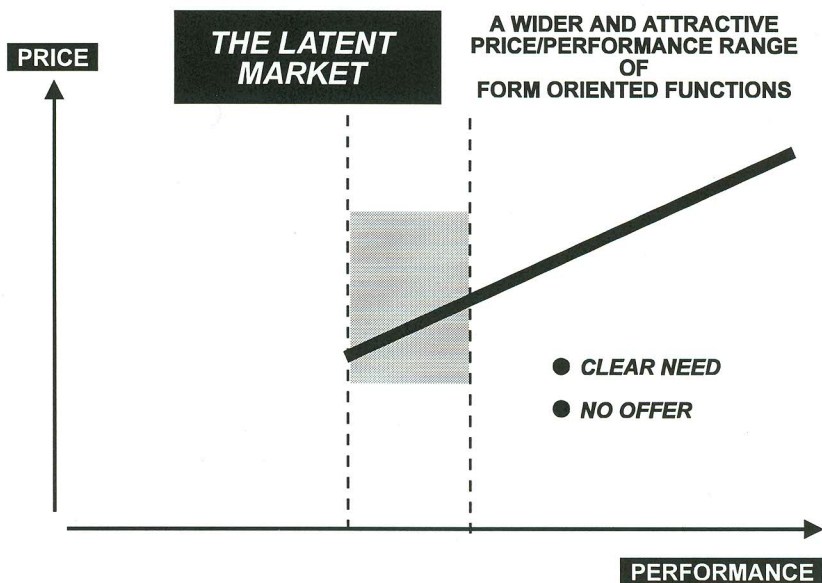

Compuprint Division

BPCC - 18 -

Bull



THE CHALLENGE

**SERVE THE
FORM ORIENTED PRINTING
LATENT MARKET**

FORM ORIENTED PRINTING MARKET

***a NEW PLATFORM INVESTMENT as
a GLOBAL INDUSTRIAL RESPONSE***

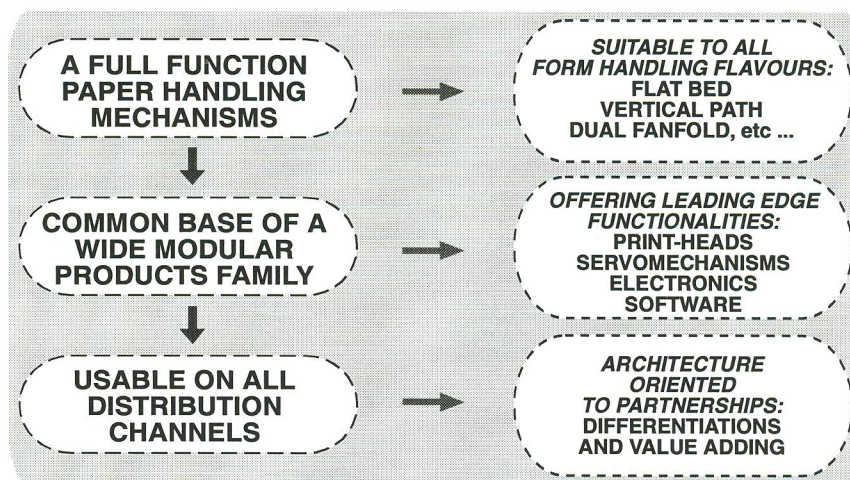

HIGH END SIDM PRINTING: SURVIVING THE CHALLENGE

- AN INNOVATIVE APPROACH

Compuprint Division

BPCC - 21 -



AN INNOVATIVE APPROACH - THE VEGA ARCHITECTURE

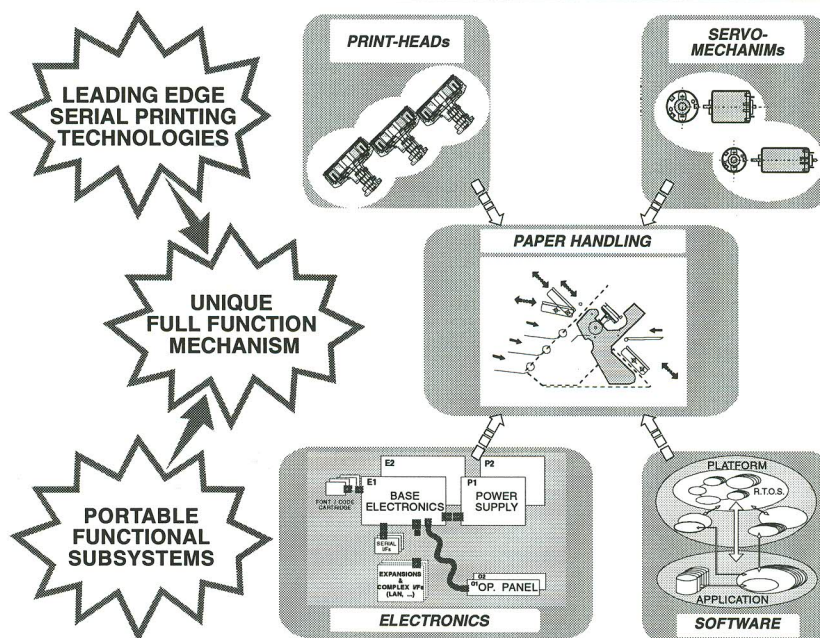

Compuprint Division

BPCC - 22 -



AN INNOVATIVE APPROACH - THE VEGA ARCHITECTURE

A NEW LEVEL OF MODULARITY

MODELS SUBSYSTEMS MATRIX

	Mod L-9	Mod M-9	Mod L-24	Mod M-24	Mod H-24	Mod H-18	Mod T-18
SOFTWARE	S1	S1	S1	S1	S1	S1	S1
OPERATOR PANEL	O0	O0	O1	O1	O2	O1	O2
ELECTRONICS	E1	E1	E1	E1	E2	E2	E2
POWER SUPPLY	P0	P1	P1	P1	P2	P2	P2
PRINT-HEAD	T1	T2	T3	T4	T5	T6	T7
SERVO MECHANISMS	A1	A2	A1	A2	A3	A2	A3
PAPER HANDLING	H1	H2	H1	H2	H2	H2	H2
FRAME	C1	C1	C1	C1	C1	C1	C1

FUNCTIONAL SUBSYSTEMS

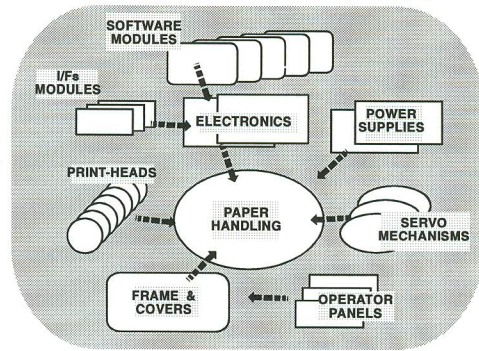

SUBSYSTEMS INTERFACES

ARCHITECTURAL TECHNOLOGICAL PHYSICAL

Compuprint Division

BPCC - 23 -



AN INNOVATIVE APPROACH - THE VEGA ARCHITECTURE

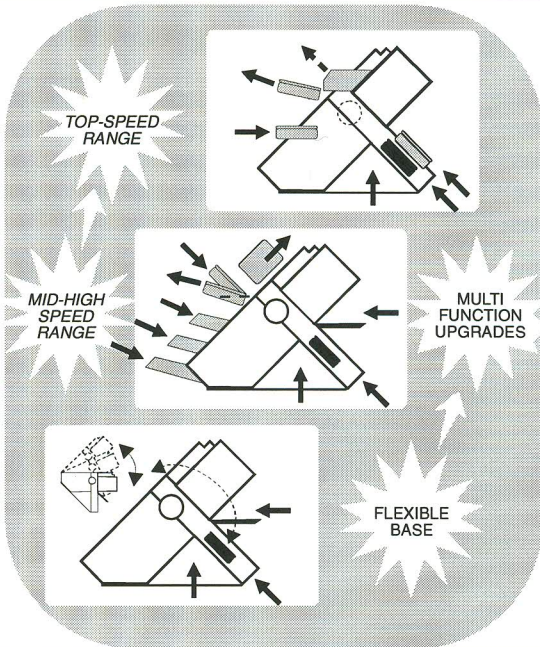

A NEW FULL FUNCTION PAPER HANDLING MECHANISM

COMMON TO DIFFERENT FUNCTIONS AND SPEEDS

ARCHITECTURAL DESIGN for UPGRADING and PERSONALIZATION

TECHNOLOGICAL SOLUTIONS for RE-USABILITY and DERIVATIONS

Compuprint Division

BPCC - 24 -



AN INNOVATIVE APPROACH - THE VEGA ARCHITECTURE

A NEW PRINT-HEADS FAMILY

9-18-24 PINS
IMPROVED
COST / PERFORMANCE

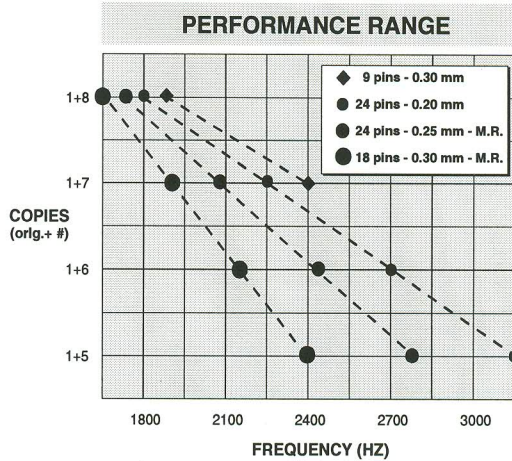
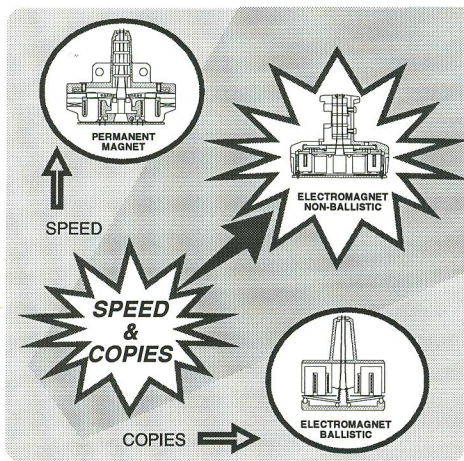

Compuprint Division

BPCC - 25 -



AN INNOVATIVE APPROACH - THE VEGA ARCHITECTURE

ELECTRONICS

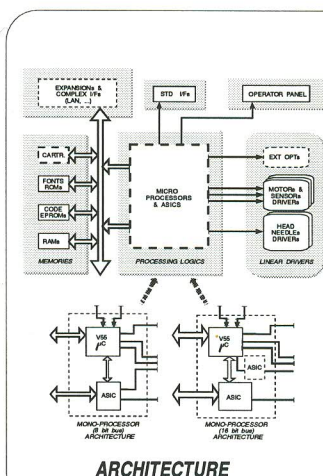
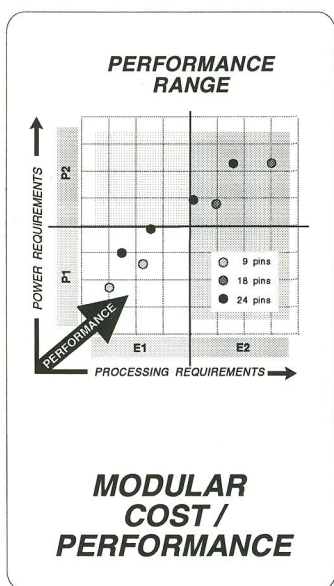

COMMON ARCHITECTURAL
& PHYSICAL BASES
to different
TECHNOLOGICAL SOLUTIONS

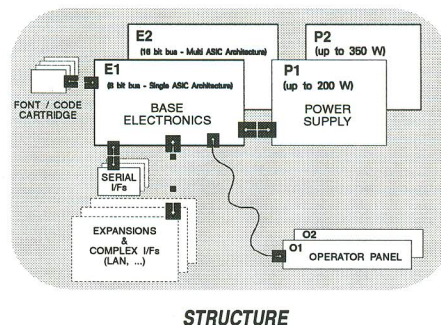

Compuprint Division

BPCC - 26 -



AN INNOVATIVE APPROACH - THE VEGA ARCHITECTURE

SOFTWARE

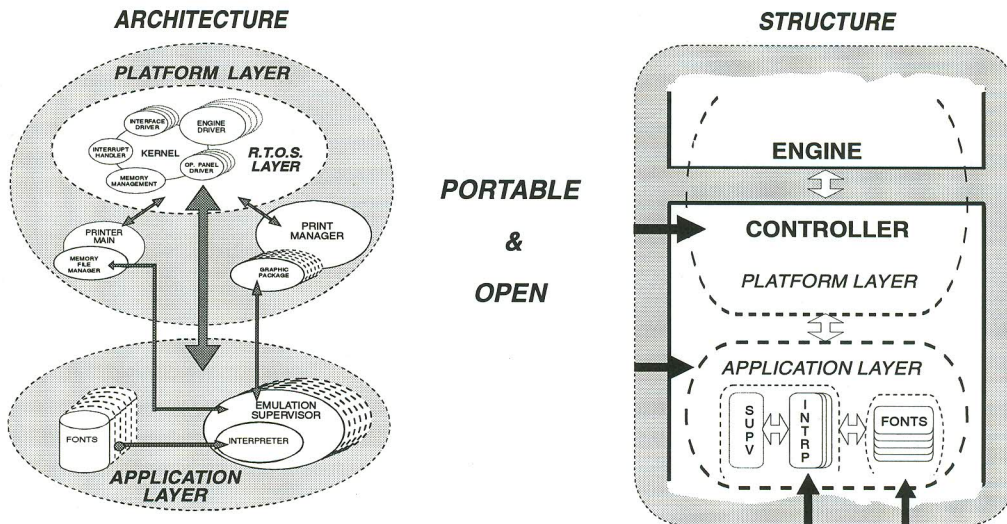

Compuprint Division

BPCC - 27 -



AN INNOVATIVE APPROACH

SIGNUM - THE FIRST PRODUCTS BASED ON VEGA ARCHITECTURE

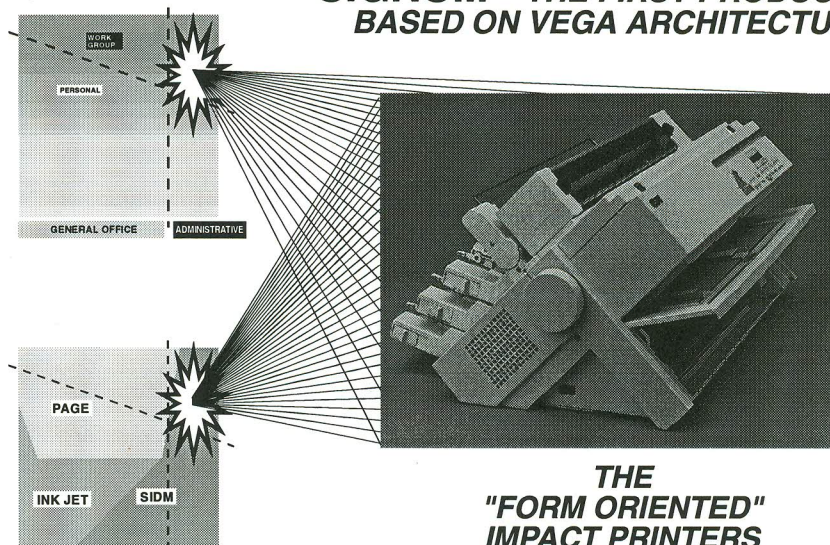

Compuprint Division

BPCC - 28 -

